

# Product Specifications

|                     |  |
|---------------------|--|
| <b>Product Name</b> | Draped Baffles 001   |
| <b>Product ID</b>   | BFL-DRP-001  |
| <b>Acoustics</b>    | 0.85 NRC*  |
| <b>Lead Time</b>    | Lead time is dependent on project size. Contact us for more information. |
| <b>Durability</b>   | Contract   |

|                     |  |
|---------------------|--|
| <b>Warranty</b>     | Comes with industry-leading standard warranty.   |
| <b>Flammability</b> | ASTM E84: Class A  |
| <b>Custom</b>       | Custom colors and manufacturing services available. Additional charges and lead times may apply.   |
| <b>Maintenance</b>  | Vacuum occasionally to remove airborne dust or debris. Mild detergents or soaps may be used to remove stains. For detailed care instructions, refer to the <b>CSI Creative Maintenance Information</b> document. |

# Material Specifications

|                      |   |  |
|----------------------|---|--|
|                      | <b>Soundcore®</b>   | <b>PoshFelt®</b>   |
| <b>Content</b>       | Recycled PET acoustic felt  | 100% Merino or Karakul wool acoustic felt  |
| <b>Weathering</b>    | Colorfast, non-deteriorating, non-hygroscopic   | Colorfast, non-deteriorating, non-woven, moisture resistant  |
| <b>Environmental</b> | Recycled PET acoustic felt is 60% post-consumer recycled content and is 100% recyclable. Contributes points toward LEED v4, CDPH v1.2, VOC free, non-toxic, non-allergenic, anti-microbial - does not attract mold and mildew. Compliant with Living Building Challenge criteria & DECLARE Red List Free. | 100% organic wool design felt is a rapidly renewable resource and is 100% biodegradable/compostable. Contributes points toward LEED v4, CDPH v1.2, VOC free, no chemical irritants, no formaldehyde, and is free of other harmful substances. Compliant with Living Building Challenge criteria & DECLARE Red List Free. |
| <b>Variation</b>     | PET felt panels are created through a manufacturing process known as 'felting'. This process results in a heathered appearance. Multiple color tones may appear in the same panel. Slight color variations should be expected.  | Due to its 100% natural origin, the raw fibers of wool felt contain inclusions and color variations throughout the material. Color matching is not guaranteed between dye lots and inconsistencies may be more prominent in volumes that exceed the normal commercial standard.  |

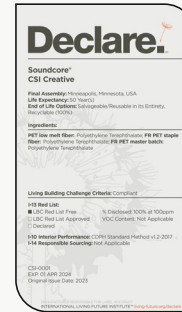

\*Approximate. NRC rating may vary due to product dimensions and spacing.

## Dimensions

### Standard Unit Dimensions

Typical ranges for length and height.

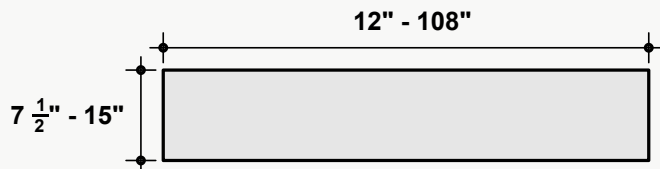

### Custom Opportunity

Product dimensions can be manipulated in order to fit your design aesthetic and site conditions.

### Standard Unit Thicknesses

Thickness is dependent on material layer selection.

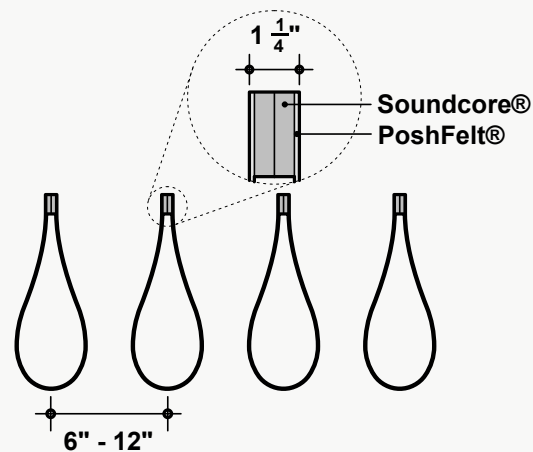

### On-Center Spacing

Our standard product spacing is 6"-12" on-center. Acoustic performance of the product improves as spacing is reduced.

### Standard Unit Widths

Width is dependent on unit height.

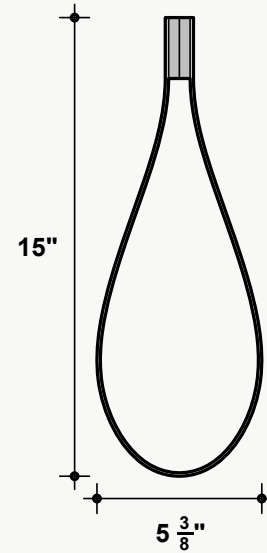
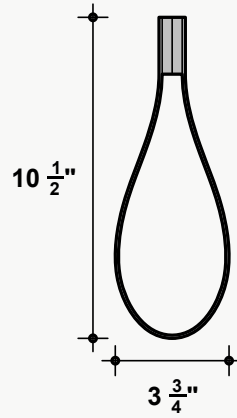
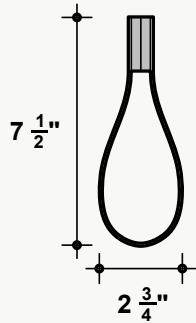

## Product Details

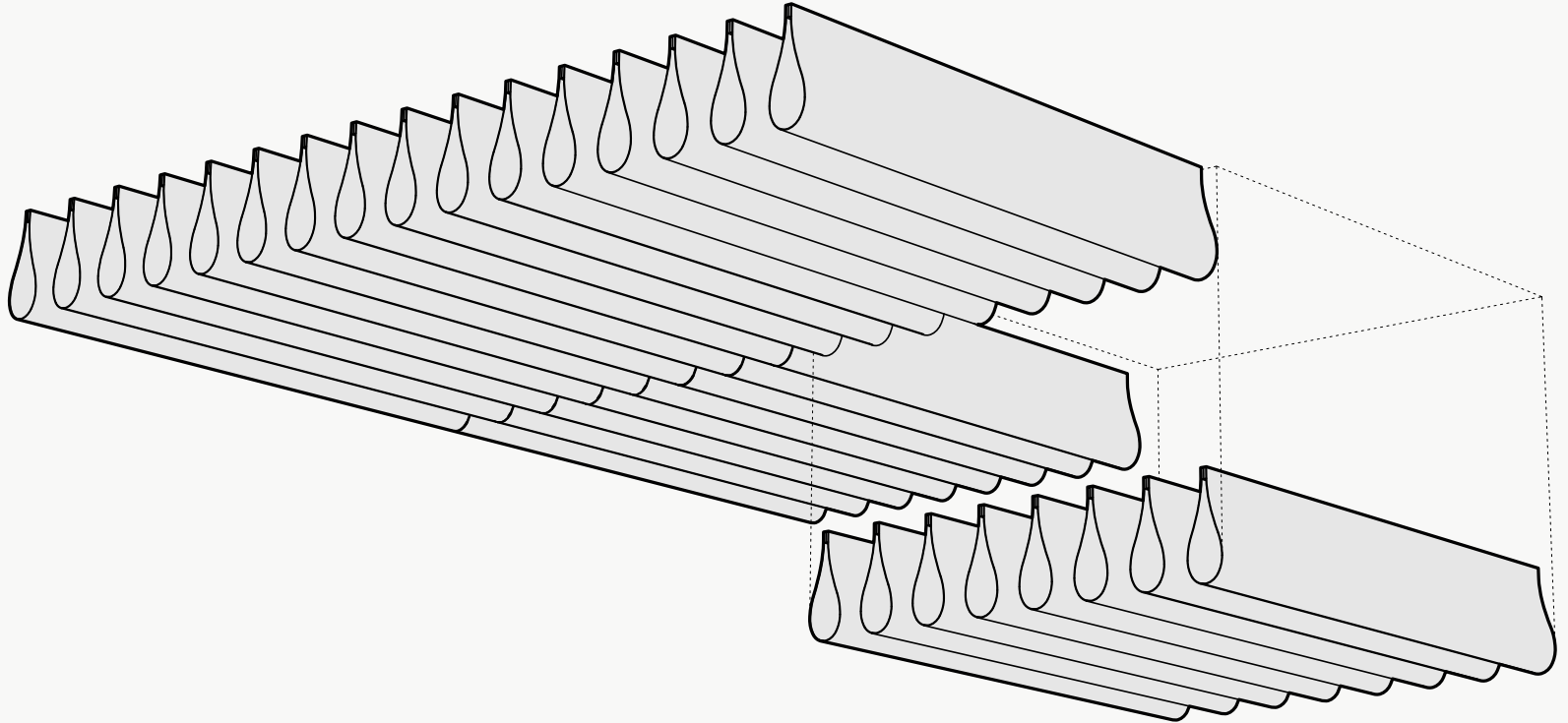

# Installation Options

All products and installation methods can be **customized** to meet the unique requirements of your space.

## Rail Suspension Advantages

Rail suspension installation methods are designed for fast and easy installation by reducing the amount of suspension points. The rail structure acts as a guide for the baffles, maintaining baffle spacing and orientation while remaining easily customizable to fit most RCP layouts.

Pre-Defined Spacing

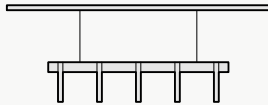

Consistent Angle

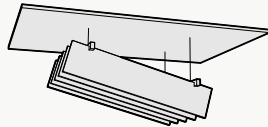

Non-Perpendicular Arrangements



## Individual Suspension Advantages

Individual suspension installation methods excel at accommodating irregular layouts. They are the most versatile installation style, and can be customized to fit even the most unique RCP layout.

Height Variation

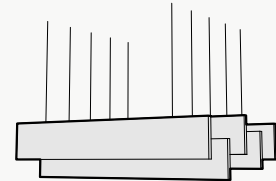

Angle Variation

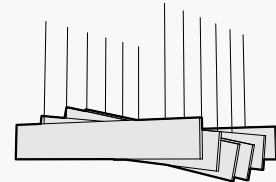

Non-Linear Arrangements

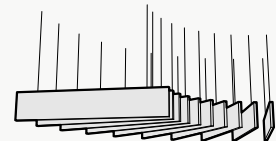

## Attachment Methods\*

### Rail Suspension

#### Aircraft Cable

- + Fastest/easiest height adjustment
- + Largest height adjustment range
- + Height and angle versatility
- + Accommodates uneven ceiling surfaces and MEP

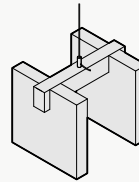

### Individual Suspension

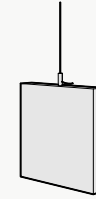

#### Threaded Rod

- + Reduced product sway
- + Height and angle versatility
- + Accommodates uneven ceiling surfaces and MEP

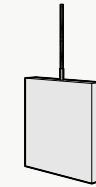
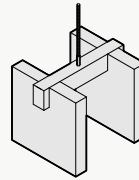

#### Mechanical Direct

- + Lowest profile installation method
- + Eliminates product sway
- + Connects to: Unistrut, ACT Grid, flat ceiling surfaces
- + Connections: Magnets, Grid Clips, Panel Clips, Metal Bracket, Custom

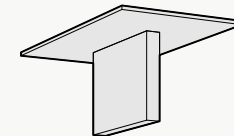
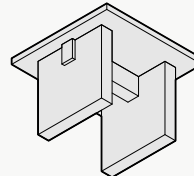

\*Not all listed attachment methods may be applicable to this product.

## Material Layers

### Soundcore®

Our recycled PET felt creates an acoustic barrier, defending against wandering white noise and irritating echoes.

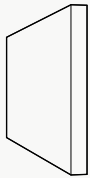

**Single Layer**  
½" Thickness

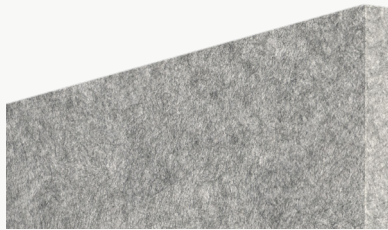

### PoshFelt® Exposed Edge

100% organic, natural wool design felt brings out the best experience in your space with color, comfort, and simple sustainability. Exposed edge products leave the Soundcore® layer uncovered, allowing for unique color combinations.

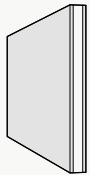

**Multi-Layer**  
Adds ⅛"-¼" to Material Thickness





PoshFelt® | 3mm Thickness



**PSH005**  
Black Beauty

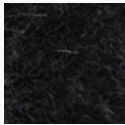

**PSH161**  
Black Swan



**PSH266**  
Koala

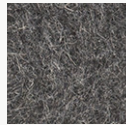

**PSH001**  
Gray Matter

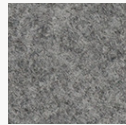

**PSH176**  
Warmstone

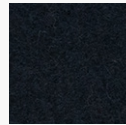

**PSH627**  
Blackberry



**PSH265**  
Slag



**PSH513**  
Gravel

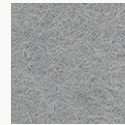

**PSH512**  
Ash Plume

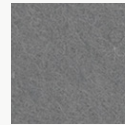

**PSH004**  
Porpoise



**PSH625**  
Silver Chain



**PSH609**  
Cityscape

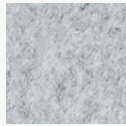

**PSH300**  
Crevasse

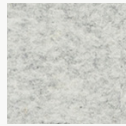

**PSH299**  
Mountain Breeze

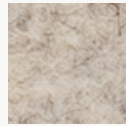

**PSH515**  
Blizzard

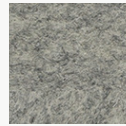

**PSH175**  
Dovetail

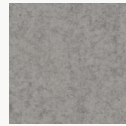

**PSH624**  
Dapple Gray

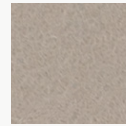

**PSH127**  
Mocha

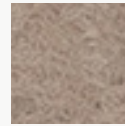

**PSH635**  
Eggshell



**PSH178**  
Fawn



**PSH520**  
Silt



**PSH002**  
Heather



**PSH003**  
Otter

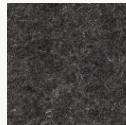

**PSH179**  
Arctic Seal

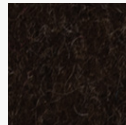

**PSH180**  
Iron Ore

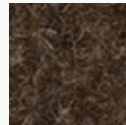

**PSH545**  
Henna

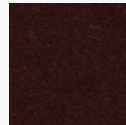

**PSH249**  
French Press



**PSH248**  
Mink

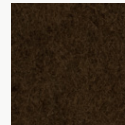

**PSH146**  
Auburn

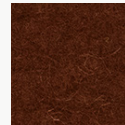

**PSH521**  
Cocoa



**PSH269**  
Canyon



**PSH253**  
Toffee



**PSH602**  
Cafe



**PSH268**  
Gingerbread



**PSH255**  
Tropical Walnut



**PSH504**  
Earth



**PSH505**  
Garrigue



**PSH503**  
Savanna



**PSH509**  
Cairo



**PSH621**  
Pan

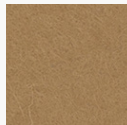

**PSH281**  
Great Plains

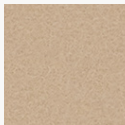

**PSH291**  
Gobi



**PSH630**  
Sand Dune

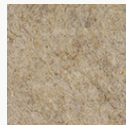

**PSH006**  
Shiitake

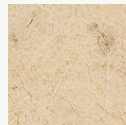

**PSH519**  
Cupcake

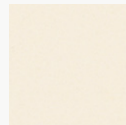

**PSH118**  
Ivory Lace

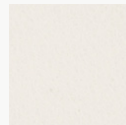

**PSH174**  
Cotton

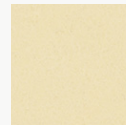

**PSH293**  
Pound Cake



**PSH637**  
Chiffon

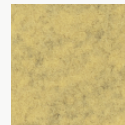

**PSH304**  
Sugar Cookie

PoshFelt® | 3mm Thickness



**PSH301**  
Tumbleweed



**PSH541**  
Banana Bread



**PSH622**  
Corn



**PSH215**  
Raincoat



**PSH305**  
Dandelion

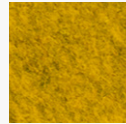

**PSH216**  
Lion's Den



**PSH015**  
Honey



**PSH217**  
Citrine



**PSH507**  
Hive



**PSH634**  
Amber



**PSH261**  
Pale Ale



**PSH638**  
Sunflower



**PSH295**  
Sunrise Peach



**PSH610**  
Coral



**PSH632**  
Peach



**PSH251**  
Summer Dream



**PSH218**  
Citrus



**PSH532**  
Harvest



**PSH014**  
Knockout Orange

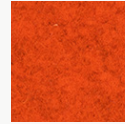

**PSH307**  
Orange Nectar



**PSH633**  
Clementine



**PSH245**  
Fire Agate



**PSH525**  
Olympus



**PSH640**  
Rusted



**PSH528**  
Ferrous



**PSH296**  
Paprika

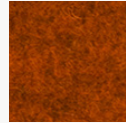

**PSH220**  
Red Earth



**PSH530**  
Hot Iron



**PSH537**  
Cardinal



**PSH535**  
Guppy

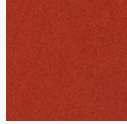

**PSH139**  
Cayenne



**PSH008**  
Bonfire



**PSH308**  
Scarlet

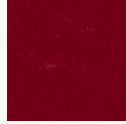

**PSH009**  
Poinsettia

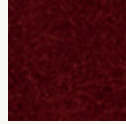

**PSH540**  
Devil's Food

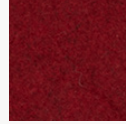

**PSH527**  
Red Velvet

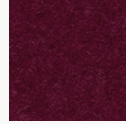

**PSH644**  
Maroon

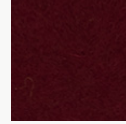

**PSH210**  
Sangria

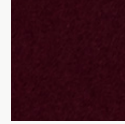

**PSH211**  
Cherry Chutney

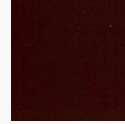

**PSH212**  
Vino

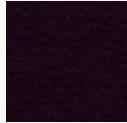

**PSH514**  
Red Wine



**PSH617**  
Evening Gown



**PSH649**  
Pomegranate



**PSH273**  
Ultraviolet



**PSH137**  
Passion Flower



**PSH272**  
Hotwire



**PSH302**  
Heather Pink

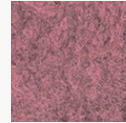

**PSH292**  
Sakura Mist



**PSH202**  
Crush

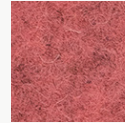

**PSH560**  
Schiava

PoshFelt® | 3mm Thickness



PSH647  
Eden Rose



PSH643  
Rhododendron



PSH559  
Monroe

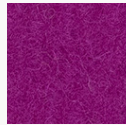

PSH544  
Dragonfruit



PSH309  
Allium



PSH205  
Mulberry



PSH546  
Tyrian Plum



PSH142  
Plum Purple



PSH523  
Violet Sky



PSH612  
Lilac



PSH286  
Viper



PSH646  
Lupine

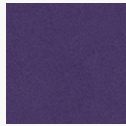

PSH274  
Amethyst

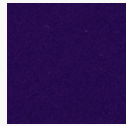

PSH275  
Skyfall

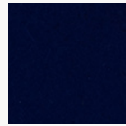

PSH241  
Tranquilo

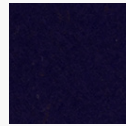

PSH550  
Mariana

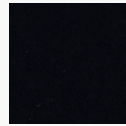

PSH277  
Shade



PSH310  
Deep Royal

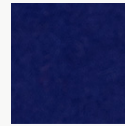

PSH160  
Admiral Blue



PSH561  
Neptune



PSH239  
Speckled Navy

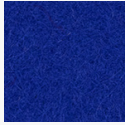

PSH548  
Ultramarine



PSH645  
Space



PSH508  
Oahu

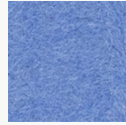

PSH510  
Ozone

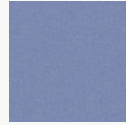

PSH615  
Imagine



PSH614  
Blueberry

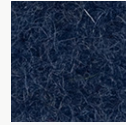

PSH636  
Navy Blue



PSH278  
Squid Ink



PSH260  
Twilight



PSH616  
Fountain

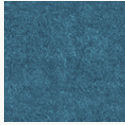

PSH604  
Atlantic



PSH237  
Hotspring



PSH238  
Cobalt

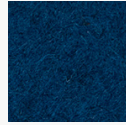

PSH516  
Actun

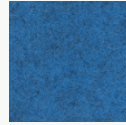

PSH502  
Pacific



PSH511  
Lagoon



PSH152  
Blue Nile



PSH149  
Jamaica Bay



PSH623  
Steel Gray



PSH648  
Aegean



PSH236  
Aquamarine



PSH016  
Freshwater



PSH306  
Swell

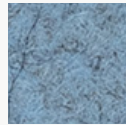

PSH608  
Diamond Dust

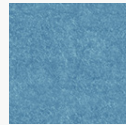

PSH605  
Meander



PSH639  
Glacier



PSH606  
Midday



PSH650  
Waterfall



PSH287  
Sea Breeze

PoshFelt® | 3mm Thickness



**PSH628**  
Cozumel

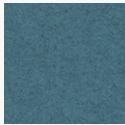

**PSH631**  
Adriatic



**PSH552**  
Cancun



**PSH564**  
Jazz



**PSH517**  
Sky Stone



**PSH232**  
Seaglass

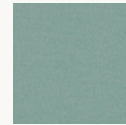

**PSH641**  
Basil



**PSH629**  
Robin's Egg

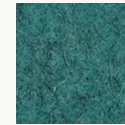

**PSH642**  
Blue Spruce

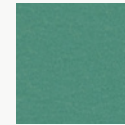

**PSH618**  
Iguana

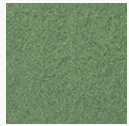

**PSH213**  
Meadow

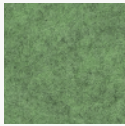

**PSH303**  
Feather Moss

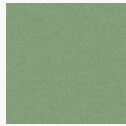

**PSH619**  
Springtime

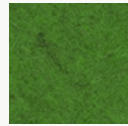

**PSH223**  
Matrix



**PSH164**  
Fresh Lime



**PSH225**  
Everglade



**PSH226**  
Grove



**PSH298**  
Peacock

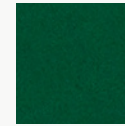

**PSH234**  
Ocean Trench



**PSH311**  
Emerald

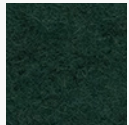

**PSH626**  
Evergreen

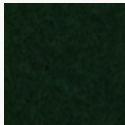

**PSH228**  
Forest Haze

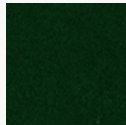

**PSH227**  
Succulent

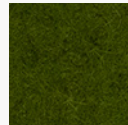

**PSH563**  
Rosemary

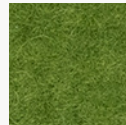

**PSH555**  
Hemlocks

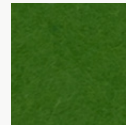

**PSH012**  
Shamrock



**PSH554**  
Cyber Green

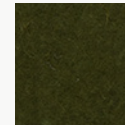

**PSH501**  
Mire

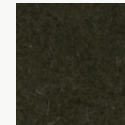

**PSH506**  
Bracken

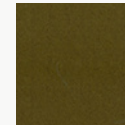

**PSH312**  
Safari



**PSH611**  
Haybale



**PSH230**  
Camouflage



**PSH556**  
Avocado

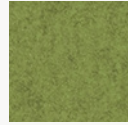

**PSH562**  
Aurora

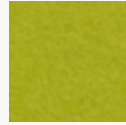

**PSH013**  
Parakeet

Soundcore® | 1/2" Thickness

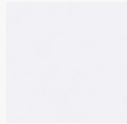

SND019  
Linen



SND037  
Paper



SND134  
Oat



SND135  
Vanilla Bean



SND105  
Sand Dollar



SND109  
Macadamia



SND111  
Lanai



SND130  
Buckskin

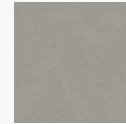

SND131  
Abalone

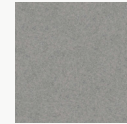

SND125  
Chinchilla

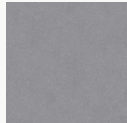

SND118  
Anchor

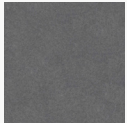

SND126  
Wolfhound

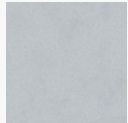

SND110  
Starry Night

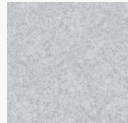

SND102  
Morning Fog

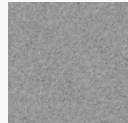

SND114  
Lunar Dust

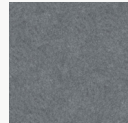

SND034  
Granite Peak

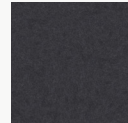

SND132  
Cast Iron

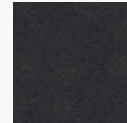

SND103  
Storm Cloud



SND038  
Inkwell

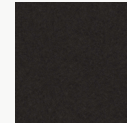

SND122  
Briquette

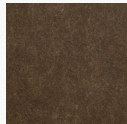

SND127  
Burnt Toast

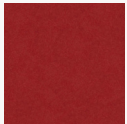

SND108  
Ablaze

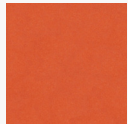

SND104  
Pumpkin



SND106  
Goldfinch

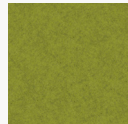

SND113  
Gruner

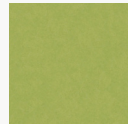

SND107  
Grasshopper



SND136  
Clover

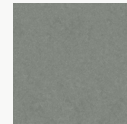

SND129  
Dried Thyme

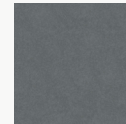

SND115  
Mako

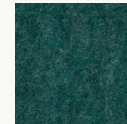

SND137  
Cove



SND112  
Tulum



SND121  
Apatite

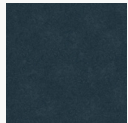

SND123  
Chrysocolla

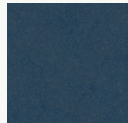

SND117  
Serene

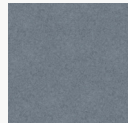

SND124  
Ice Floe

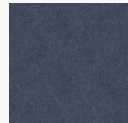

SND128  
Arctic Ocean

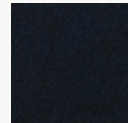

SND133  
Galactic



SND116  
Blue Marlin

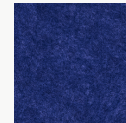

SND101  
Commodore

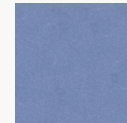

SND042  
Denim