

Product Specifications

Product Name	Folded Baffles 008
Product ID	BFL-FLD-008
Acoustics	0.75 - 0.95 NRC*
Lead Time	Lead time is dependent on project size. Contact us for more information.
Durability	Contract

Warranty	Comes with industry-leading standard warranty.
Flammability	ASTM E84: Class A
Custom	Custom colors and manufacturing services available. Additional charges and lead times may apply.
Maintenance	Vacuum occasionally to remove airborne dust or debris. Mild detergents or soaps may be used to remove stains. For detailed care instructions, refer to the CSI Creative Maintenance Information document.

Material Specifications

Soundcore®	
Content	Recycled PET acoustic felt
Weathering	Colorfast, non-deteriorating, non-hygroscopic
Environmental	Recycled PET acoustic felt is 60% post-consumer recycled content and is 100% recyclable. Contributes points toward LEED v4. CDPH v1.2. VOC free, non-toxic, non-allergenic, anti-microbial - does not attract mold and mildew. Compliant with Living Building Challenge criteria & DECLARE Red List Free.
Variation	PET felt panels are created through a manufacturing process known as 'felting'. This process results in a heathered appearance. Multiple color tones may appear in the same panel. Slight color variations should be expected.



*Approximate. NRC rating may vary due to product dimensions and spacing.

Dimensions

Standard Unit Dimensions

Typical ranges for length and height.

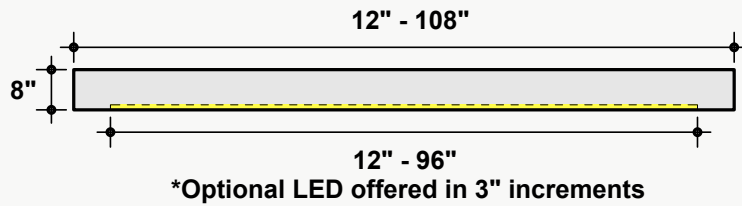

Custom Opportunity

Product dimensions can be manipulated in order to fit your design aesthetic and site conditions.

Standard Unit Thicknesses

Thickness is independent of material layer selection.

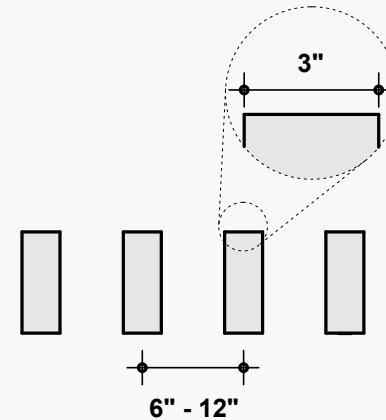

On-Center Spacing

Our standard product spacing is 6"-12" on-center. Acoustic performance of the product improves as spacing is reduced.

Product Details

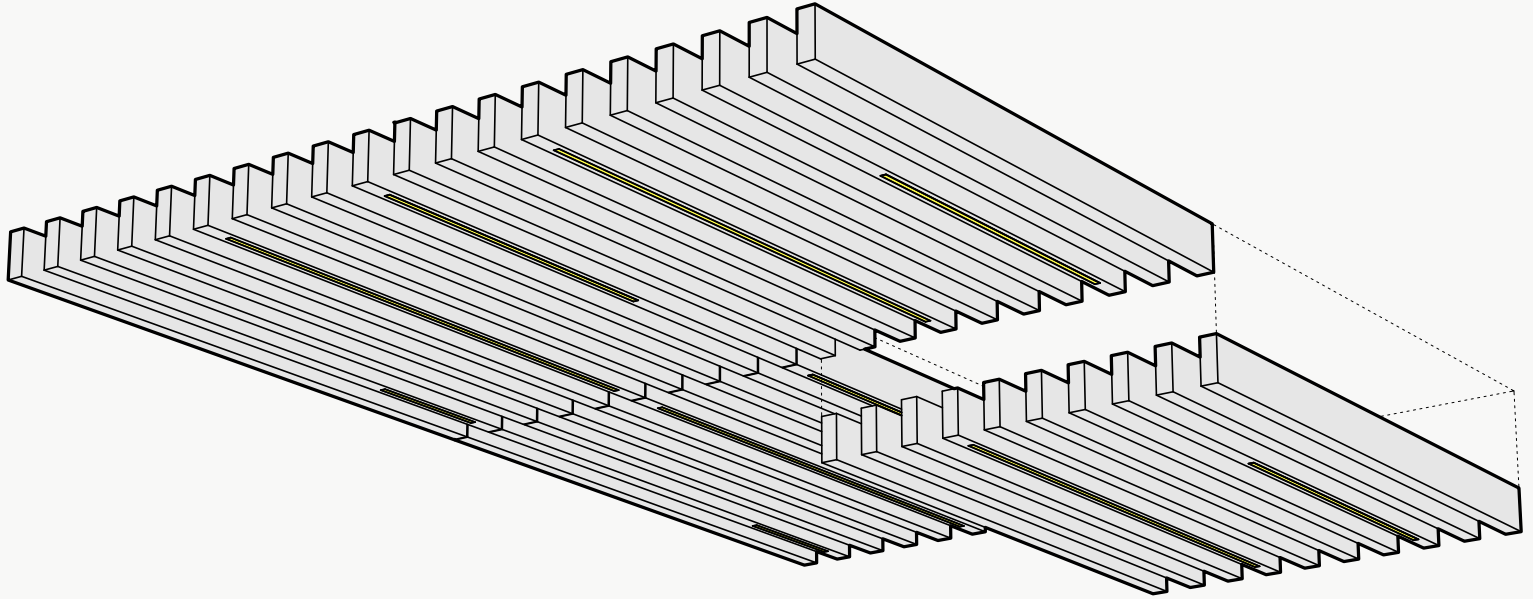

Configuration Options

Layouts

The layouts shown are a summation of individual units. Individual units may be assembled in various arrangements to dictate the larger design. Configurations shown are suggested, but can be rearranged to achieve a custom layout.

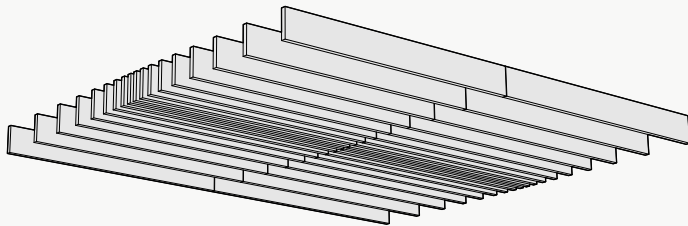

Spacing Variation

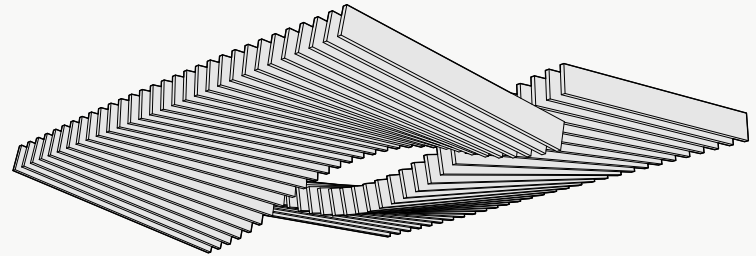

Angle Variation

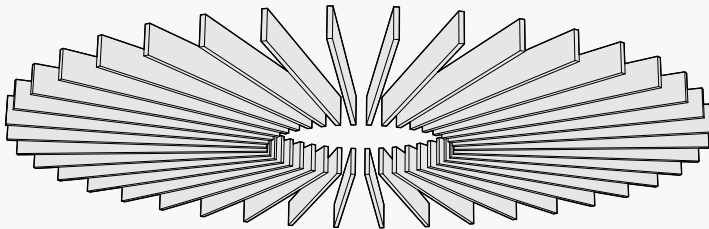

Non-Linear Arrangement

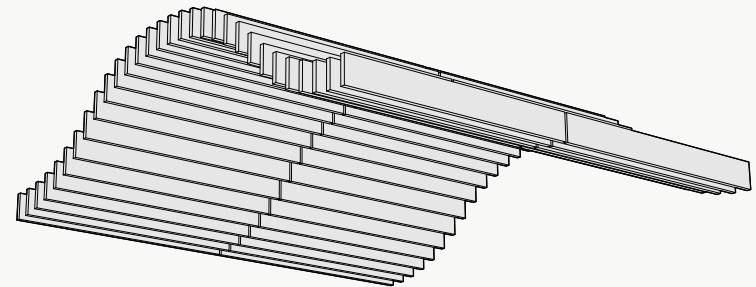

Height Variation

Lighting Specs

Lighting Fixture Features:

- + Square profile: 0.94" x 0.94"
- + UL listed, CSA 22.2 compliant
- + RoHS compliance and lead free

Lighting Fixture Dimensions:

← 12" to 96" →



Available in 3" increments.

← 0.938" →



Direct Wide 110° - Performance Per 1' - Tested at 3500K, 80+ CRI

350 Lumen at 80+ CRI

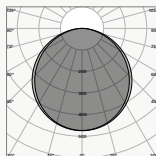

LED Output	Color Temp	Watts	Direct Lumens	Efficacy LPW	Ratio
Eco-Low	3000K	3.1	346	113	0.97
Eco-Low	3500K	3.0	346	116	1.00
Eco-Low	4000K	2.8	346	122	1.05

500 Lumen at 80+ CRI

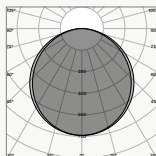

LED Output	Color Temp	Watts	Direct Lumens	Efficacy LPW	Ratio
Low	3000K	4.5	507	112	0.97
Low	3500K	4.4	507	115	1.00
Low	4000K	4.2	507	121	1.05

750 Lumen at 80+ CRI

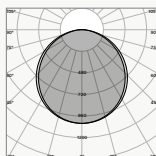

LED Output	Color Temp	Watts	Direct Lumens	Efficacy LPW	Ratio
Medium	3000K	7.1	762	108	0.97
Medium	3500K	6.9	762	111	1.00
Medium	4000K	6.5	762	117	1.05

1000 Lumen at 80+ CRI

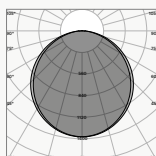

LED Output	Color Temp	Watts	Direct Lumens	Efficacy LPW	Ratio
High	3000K	9.4	1000	107	0.97
High	3500K	9.1	1000	110	1.00
High	4000K	8.6	1000	116	1.05

Installation Options

All products and installation methods can be **customized** to meet the unique requirements of your space.

Rail Suspension Advantages

Rail suspension installation methods are designed for fast and easy installation by reducing the amount of suspension points. The rail structure acts as a guide for the baffles, maintaining baffle spacing and orientation while remaining easily customizable to fit most RCP layouts.

Pre-Defined Spacing

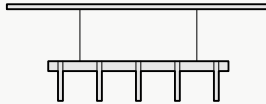

Consistent Angle

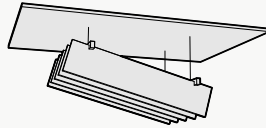

Non-Perpendicular Arrangements

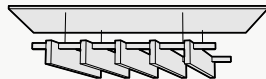

Individual Suspension Advantages

Individual suspension installation methods excel at accommodating irregular layouts. They are the most versatile installation style, and can be customized to fit even the most unique RCP layout.

Height Variation

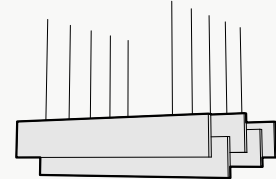

Angle Variation

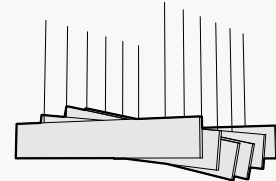

Non-Linear Arrangements

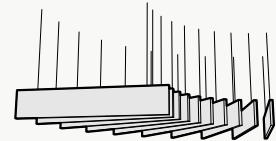

Attachment Methods*

Rail Suspension

Aircraft Cable

- + Fastest/easiest height adjustment
- + Largest height adjustment range
- + Height and angle versatility
- + Accommodates uneven ceiling surfaces and MEP

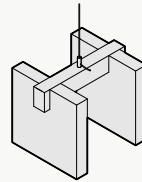

Individual Suspension

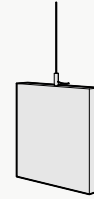

Threaded Rod

- + Reduced product sway
- + Height and angle versatility
- + Accommodates uneven ceiling surfaces and MEP

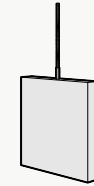
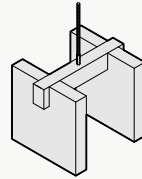

Mechanical Direct

- + Lowest profile installation method
- + Eliminates product sway
- + Connects to: Unistrut, ACT Grid, flat ceiling surfaces
- + Connections: Magnets, Grid Clips, Panel Clips, Metal Bracket, Custom

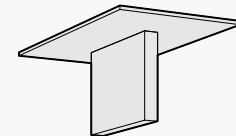
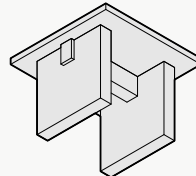

*Not all listed attachment methods may be applicable to this product.

Material Layers

Soundcore®

Our recycled PET felt creates an acoustic barrier, defending against wandering white noise and irritating echoes.

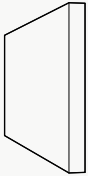

Single Layer
½" Thickness

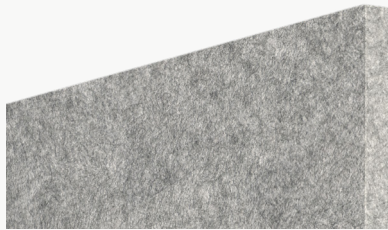

Soundcore® Wood Textures

Soundcore® wood textures provide the natural aesthetic of wood while maintaining all the acoustic benefits of PET felt. Custom texture opportunities are also available upon request.



Single Layer
½" Thickness



Soundcore® | 1/2" Thickness

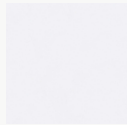

SND019
Linen

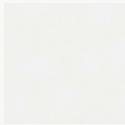

SND037
Paper



SND135
Oat



SND105
Sand Dollar



SND109
Macadamia



SND111
Lanai



SND130
Buckskin



SND131
Abalone



SND125
Chinchilla



SND118
Anchor



SND126
Wolfhound



SND110
Starry Night



SND102
Morning Fog

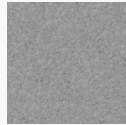

SND114
Lunar Dust



SND034
Granite Peak

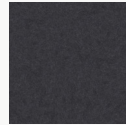

SND132
Cast Iron



SND103
Storm Cloud



SND038
Inkwell



SND122
Briquette

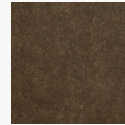

SND127
Burnt Toast

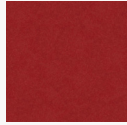

SND108
Ablaze



SND104
Pumpkin



SND106
Goldfinch



SND113
Gruner



SND107
Grasshopper

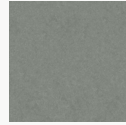

SND129
Dried Thyme

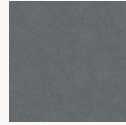

SND115
Mako



SND112
Tulum



SND121
Apatite

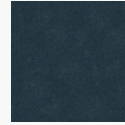

SND123
Chrysocolla



SND117
Serene



SND124
Ice Floe

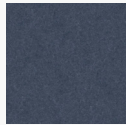

SND128
Arctic Ocean



SND133
Galactic



SND116
Blue Marlin

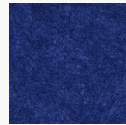

SND101
Commodore

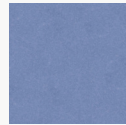

SND042
Denim

Soundcore® Wood Textures | 1/2" Thickness



SND716
Dark Teak



SND792
Dark Oak



SND715
Dark Cherry



SND793
Vintage Maple



SND794
Warm Teak



SND714
English Walnut



SND713
Honey Walnut



SND717
Warm Oak

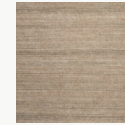

SND790
Natural Teak

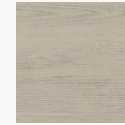

SND712
Natural Spruce



SND711
Bleached Cherry



SND795
Light Teak



SND709
White Maple



SND791
Gray Oak



SND710
Gray Teak