

STACKED SURFACES 018

SUR-STK-018

Product Specifications

| | |
|---------------------|--|
| Product Name | Stacked Surfaces 018 |
| Product ID | SUR-STK-018 |
| Acoustics | 0.80 NRC* |
| Lead Time | Lead time is dependent on project size. Contact us for more information. |
| Durability | Contract |

| | |
|---------------------|--|
| Warranty | Comes with industry-leading standard warranty. |
| Flammability | ASTM E84: Class A |
| Custom | Custom colors and manufacturing services available. Additional charges and lead times may apply. |
| Maintenance | Vacuum occasionally to remove airborne dust or debris. Mild detergents or soaps may be used to remove stains. For detailed care instructions, refer to the CSI Creative Maintenance Information document. |

Material Specifications

| | | |
|----------------------|---|--|
| | Soundcore® | PoshFelt® |
| Content | Recycled PET acoustic felt | 100% Merino or Karakul wool acoustic felt |
| Weathering | Colorfast, non-deteriorating, non-hygroscopic | Colorfast, non-deteriorating, non-woven, moisture resistant |
| Environmental | Recycled PET acoustic felt is 60% post-consumer recycled content and is 100% recyclable. Contributes points toward LEED v4, CDPH v1.2, VOC free, non-toxic, non-allergenic, anti-microbial - does not attract mold and mildew. Compliant with Living Building Challenge criteria & DECLARE Red List Free. | 100% organic wool design felt is a rapidly renewable resource and is 100% biodegradable/compostable. Contributes points toward LEED v4, CDPH v1.2, VOC free, no chemical irritants, no formaldehyde, and is free of other harmful substances. Compliant with Living Building Challenge criteria & DECLARE Red List Free. |
| Variation | PET felt panels are created through a manufacturing process known as 'felting'. This process results in a heathered appearance. Multiple color tones may appear in the same panel. Slight color variations should be expected. | Due to its 100% natural origin, the raw fibers of wool felt contain inclusions and color variations throughout the material. Color matching is not guaranteed between dye lots and inconsistencies may be more prominent in volumes that exceed the normal commercial standard. |

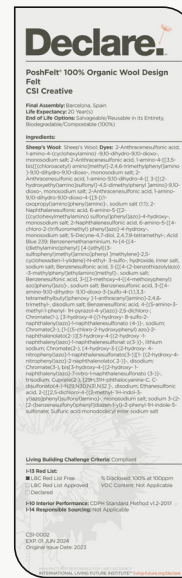
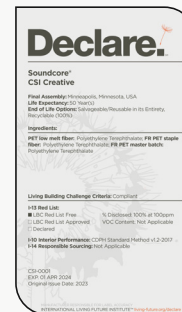

*Approximate. NRC rating may vary due to product dimensions and spacing.

Dimensions

Standard Unit Dimensions

Typical ranges for height and width.

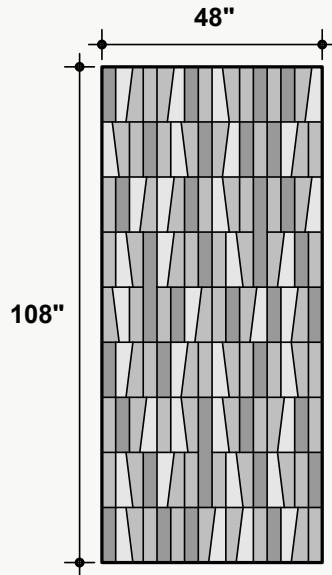

Custom Opportunity

Product dimensions can be manipulated in order to fit your design aesthetic and site conditions.

Standard Unit Thicknesses

Thickness is dependent on material layer selection.

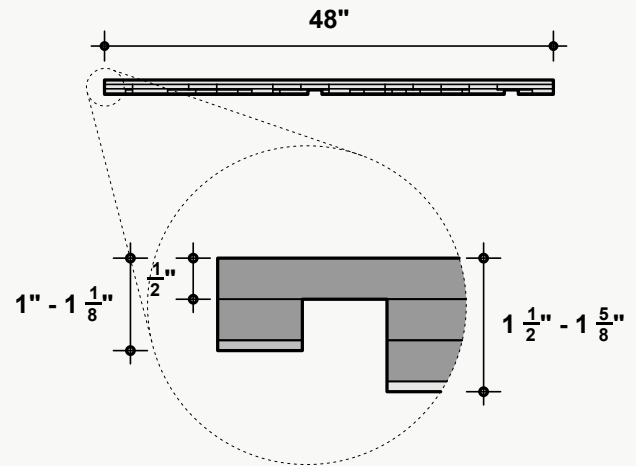

Product Details

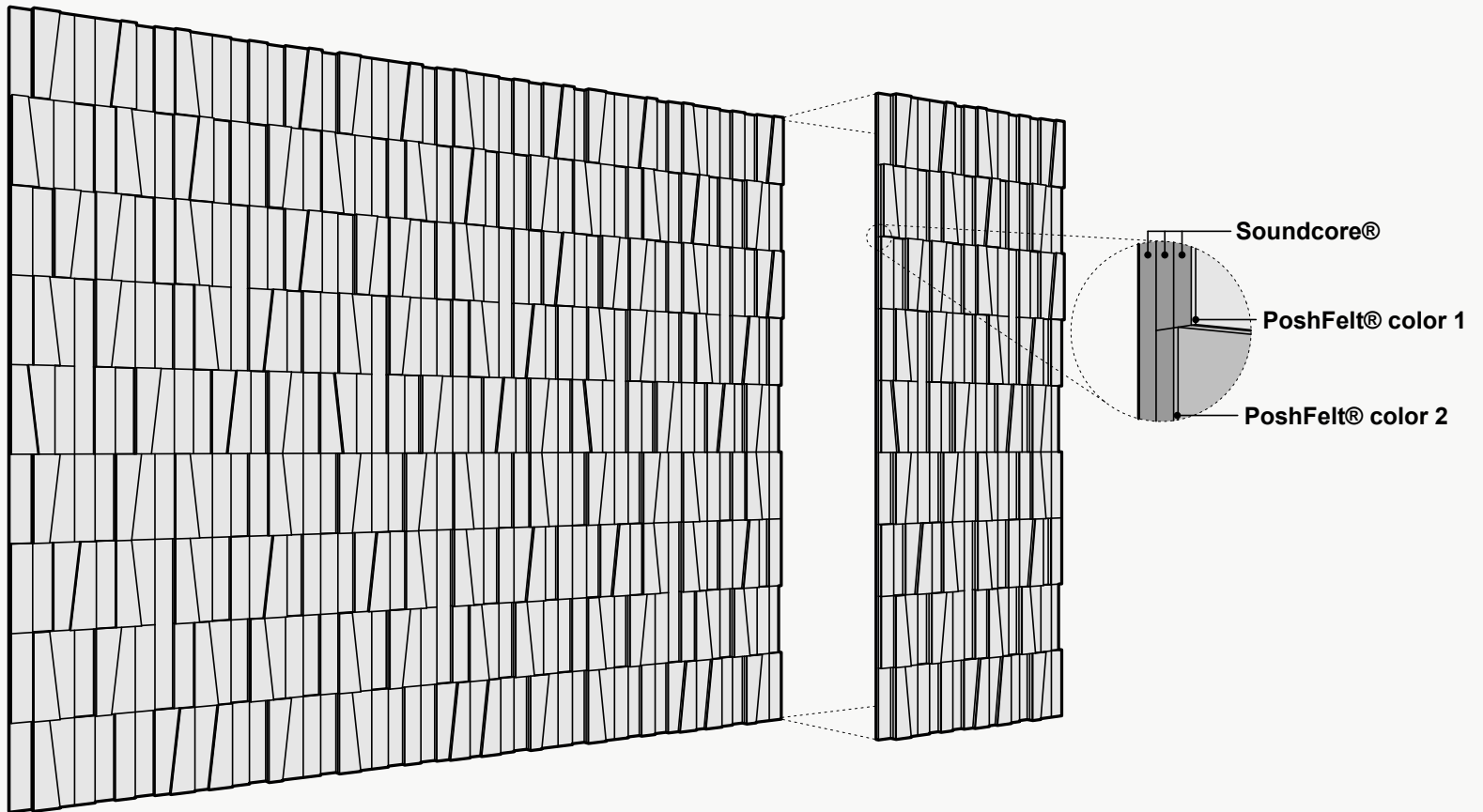

Installation Options*

All products and installation methods can be **customized** to meet the unique requirements of your space.

Adhesive Direct Advantages

Attachment solution using an adhesive to apply directly to an existing surface or substrate.

- + Fastest installation time
- + No gap between target surface and product
- + Lowest profile installation option
- + Easiest to install
- + Most versatile installation option

Available methods: Construction Adhesive, Peel & Stick, Custom

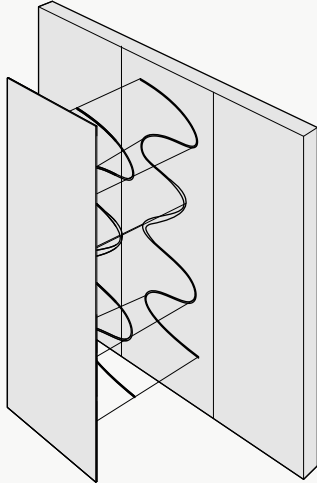

Mechanical Direct Advantages

Attachment solution using physical hardware to attach to an existing surface or substrate.

- + No clamping or dry time necessary
- + Easy to remove and does not damage the substrate when removed
- + Most appropriate installation solution for heavier products
- + Provides an opportunity for an air gap, which can increase the acoustic value of a product

Available methods: Z-Clips, Panel Clips, Standoffs, Screw & Washer, Magnet, Custom

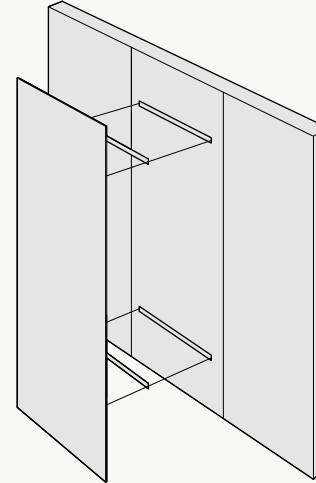

*Not all listed attachment methods may be applicable to this product.

Material Layers

Soundcore®

Our recycled PET felt creates an acoustic barrier, defending against wandering white noise and irritating echoes.

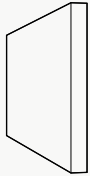

Single Layer
½" Thickness

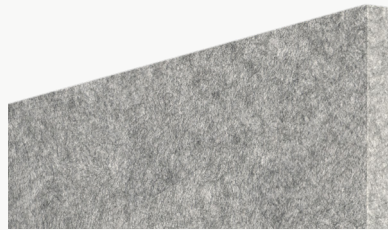

Soundcore® Wood Textures

Soundcore® wood textures provide the natural aesthetic of wood while maintaining all the acoustic benefits of PET felt. Custom texture opportunities are also available upon request.

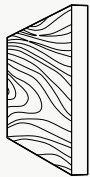

Single Layer
½" Thickness



PoshFelt® Exposed Edge

100% organic, natural wool design felt brings out the best experience in your space with color, comfort, and simple sustainability. Exposed edge products leave the Soundcore® layer uncovered, allowing for unique color combinations.

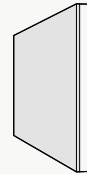

Multi-Layer
Adds ⅛"-¼" to Material Thickness



PoshFelt® | 3mm Thickness



PSH005
Black Beauty

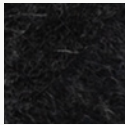

PSH161
Black Swan



PSH266
Koala

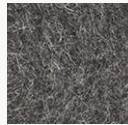

PSH001
Gray Matter

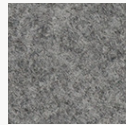

PSH176
Warmstone

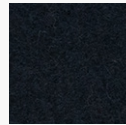

PSH627
Blackberry



PSH265
Slag

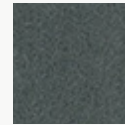

PSH513
Gravel

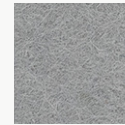

PSH512
Ash Plume

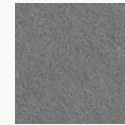

PSH004
Porpoise

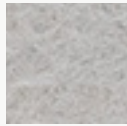

PSH625
Silver Chain

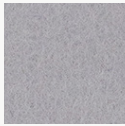

PSH609
Cityscape

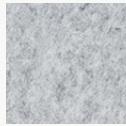

PSH300
Crevasse

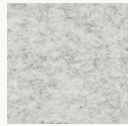

PSH299
Mountain Breeze

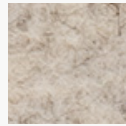

PSH515
Blizzard



PSH175
Dovetail

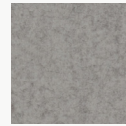

PSH624
Dapple Gray

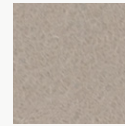

PSH127
Mocha



PSH635
Eggshell



PSH178
Fawn



PSH520
Silt

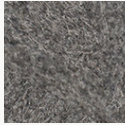

PSH002
Heather

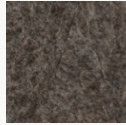

PSH003
Otter

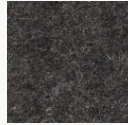

PSH179
Arctic Seal



PSH180
Iron Ore

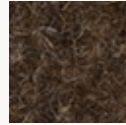

PSH545
Henna

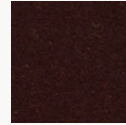

PSH249
French Press



PSH248
Mink

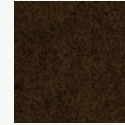

PSH146
Auburn

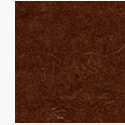

PSH521
Cocoa



PSH269
Canyon



PSH253
Toffee



PSH602
Cafe

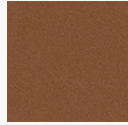

PSH268
Gingerbread



PSH255
Tropical Walnut

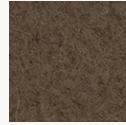

PSH504
Earth



PSH505
Garrigue



PSH503
Savanna

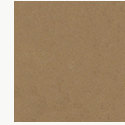

PSH509
Cairo

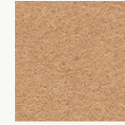

PSH621
Pan



PSH281
Great Plains



PSH291
Gobi



PSH630
Sand Dune



PSH006
Shiitake



PSH519
Cupcake

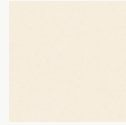

PSH118
Ivory Lace

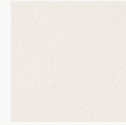

PSH174
Cotton

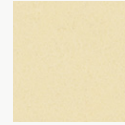

PSH293
Pound Cake



PSH637
Chiffon



PSH304
Sugar Cookie

PoshFelt® | 3mm Thickness



PSH301
Tumbleweed



PSH541
Banana Bread



PSH622
Corn



PSH215
Raincoat



PSH305
Dandelion

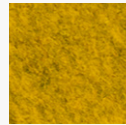

PSH216
Lion's Den



PSH015
Honey



PSH217
Citrine



PSH507
Hive



PSH634
Amber



PSH261
Pale Ale



PSH638
Sunflower



PSH295
Sunrise Peach



PSH610
Coral



PSH632
Peach



PSH251
Summer Dream



PSH218
Citrus



PSH532
Harvest



PSH014
Knockout Orange

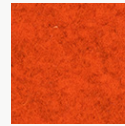

PSH307
Orange Nectar



PSH633
Clementine



PSH245
Fire Agate



PSH525
Olympus



PSH640
Rusted



PSH528
Ferrous



PSH296
Paprika

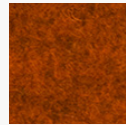

PSH220
Red Earth



PSH530
Hot Iron



PSH537
Cardinal



PSH535
Guppy

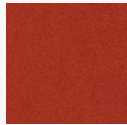

PSH139
Cayenne



PSH008
Bonfire



PSH308
Scarlet

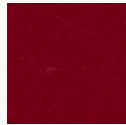

PSH009
Poinsettia

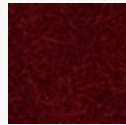

PSH540
Devil's Food



PSH527
Red Velvet

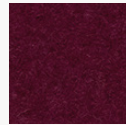

PSH644
Maroon

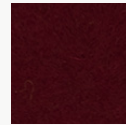

PSH210
Sangria

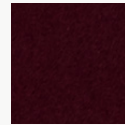

PSH211
Cherry Chutney

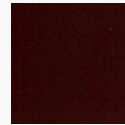

PSH212
Vino

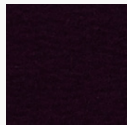

PSH514
Red Wine

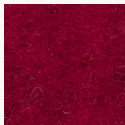

PSH617
Evening Gown

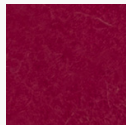

PSH649
Pomegranate

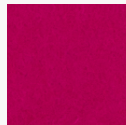

PSH273
Ultraviolet



PSH137
Passion Flower



PSH272
Hotwire

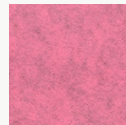

PSH302
Heather Pink

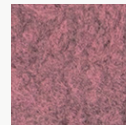

PSH292
Sakura Mist



PSH202
Crush

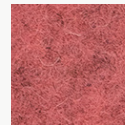

PSH560
Schiava

PoshFelt® | 3mm Thickness

| | | | | | | | | | |
|--|---|---|---|---|---|---|---|---|---|
|  |  |  |  |  |  |  |  |  |  |
| PS647 Eden Rose | PSH643 Rhododendron | PSH559 Monroe | PSH544 Dragonfruit | PSH309 Allium | PSH205 Mulberry | PSH546 Tyrian Plum | PSH142 Plum Purple | PSH523 Violet Sky | PSH612 Lilac |
|  |  |  |  |  |  |  |  |  |  |
| PSH286 Viper | PSH646 Lupine | PSH274 Amethyst | PSH275 Skyfall | PSH241 Tranquilo | PSH550 Mariana | PSH277 Shade | PSH310 Deep Royal | PSH160 Admiral Blue | PSH561 Neptune |
|  |  |  |  |  |  |  |  |  |  |
| PSH239 Speckled Navy | PSH548 Ultramarine | PSH645 Space | PSH508 Oahu | PSH510 Ozone | PSH615 Imagine | PSH614 Blueberry | PSH636 Navy Blue | PSH278 Squid Ink | PSH260 Twilight |
|  |  |  |  |  |  |  |  |  |  |
| PSH616 Fountain | PSH604 Atlantic | PSH237 Hotspring | PSH238 Cobalt | PSH516 Actun | PSH502 Pacific | PSH511 Lagoon | PSH152 Blue Nile | PSH149 Jamaica Bay | PSH623 Steel Gray |
|  |  |  |  |  |  |  |  |  |  |
| PSH648 Aegean | PSH236 Aquamarine | PSH016 Freshwater | PSH306 Swell | PSH608 Diamond Dust | PSH605 Meander | PSH639 Glacier | PSH606 Midday | PSH650 Waterfall | PSH287 Sea Breeze |

PoshFelt® | 3mm Thickness



PSH628
Cozumel



PSH631
Adriatic



PSH552
Cancun



PSH564
Jazz



PSH517
Sky Stone



PSH232
Seaglass

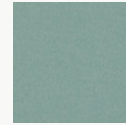

PSH641
Basil



PSH629
Robin's Egg

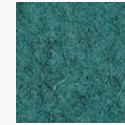

PSH642
Blue Spruce

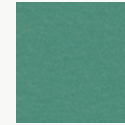

PSH618
Iguana

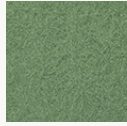

PSH213
Meadow

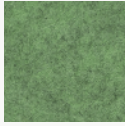

PSH303
Feather Moss

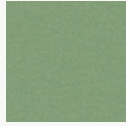

PSH619
Springtime

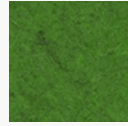

PSH223
Matrix



PSH164
Fresh Lime



PSH225
Everglade

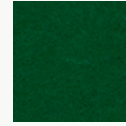

PSH226
Grove



PSH298
Peacock



PSH234
Ocean Trench



PSH311
Emerald

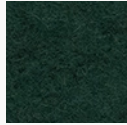

PSH626
Evergreen

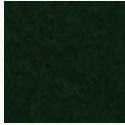

PSH228
Forest Haze



PSH227
Succulent

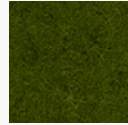

PSH563
Rosemary



PSH555
Hemlocks

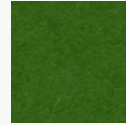

PSH012
Shamrock



PSH554
Cyber Green

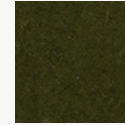

PSH501
Mire



PSH506
Bracken

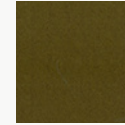

PSH312
Safari

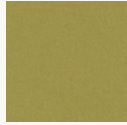

PSH611
Haybale



PSH230
Camouflage



PSH556
Avocado



PSH562
Aurora

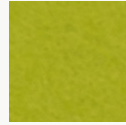

PSH013
Parakeet

Soundcore® | 1/2" Thickness

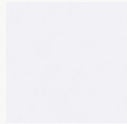

SND019
Linen

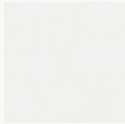

SND037
Paper



SND134
Oat



SND135
Vanilla Bean



SND105
Sand Dollar



SND109
Macadamia



SND111
Lanai



SND130
Buckskin



SND131
Abalone

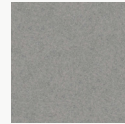

SND125
Chinchilla

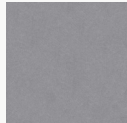

SND118
Anchor



SND126
Wolfhound

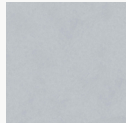

SND110
Starry Night

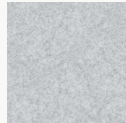

SND102
Morning Fog

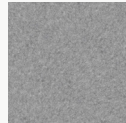

SND114
Lunar Dust



SND034
Granite Peak

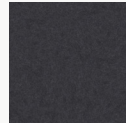

SND132
Cast Iron

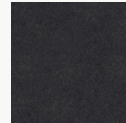

SND103
Storm Cloud

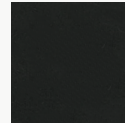

SND038
Inkwell

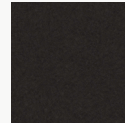

SND122
Briquette

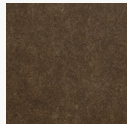

SND127
Burnt Toast

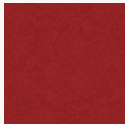

SND108
Ablaze

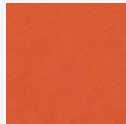

SND104
Pumpkin



SND106
Goldfinch

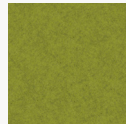

SND113
Gruner

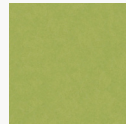

SND107
Grasshopper



SND136
Clover

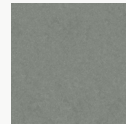

SND129
Dried Thyme

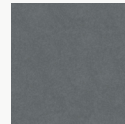

SND115
Mako

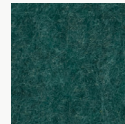

SND137
Cove



SND112
Tulum

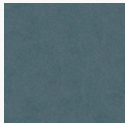

SND121
Apatite

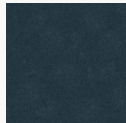

SND123
Chrysocolla

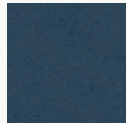

SND117
Serene

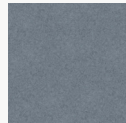

SND124
Ice Floe

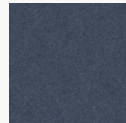

SND128
Arctic Ocean

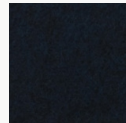

SND133
Galactic

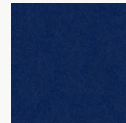

SND116
Blue Marlin

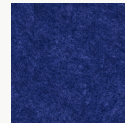

SND101
Commodore



SND042
Denim

Soundcore® Wood Textures | 1/2" Thickness



SND716
Dark Teak



SND792
Dark Oak



SND715
Dark Cherry



SND793
Vintage Maple



SND794
Warm Teak



SND714
English Walnut



SND713
Honey Walnut



SND717
Warm Oak

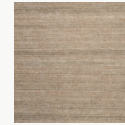

SND790
Natural Teak

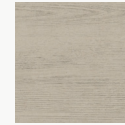

SND712
Natural Spruce



SND711
Bleached Cherry



SND795
Light Teak



SND709
White Maple

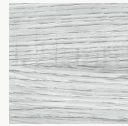

SND791
Gray Oak



SND710
Gray Teak