

# STACKED SURFACES 038

SUR-STK-038

# Product Specifications

<b>Product Name</b>	Stacked Surfaces 038
<b>Product ID</b>	SUR-STK-038
<b>Acoustics</b>	0.80 NRC*
<b>Lead Time</b>	Lead time is dependent on project size. Contact us for more information.
<b>Durability</b>	Contract

<b>Warranty</b>	Comes with industry-leading standard warranty.
<b>Flammability</b>	ASTM E84: Class A
<b>Custom</b>	Custom colors and manufacturing services available. Additional charges and lead times may apply.
<b>Maintenance</b>	Vacuum occasionally to remove airborne dust or debris. Mild detergents or soaps may be used to remove stains. For detailed care instructions, refer to the <b>CSI Creative Maintenance Information</b> document.

# Material Specifications

	<b>Soundcore®</b>	<b>PoshFelt®</b>
<b>Content</b>	Recycled PET acoustic felt	100% Merino or Karakul wool acoustic felt
<b>Weathering</b>	Colorfast, non-deteriorating, non-hygroscopic	Colorfast, non-deteriorating, non-woven, moisture resistant
<b>Environmental</b>	Recycled PET acoustic felt is 60% post-consumer recycled content and is 100% recyclable. Contributes points toward LEED v4, CDPH v1.2, VOC free, non-toxic, non-allergenic, anti-microbial - does not attract mold and mildew. Compliant with Living Building Challenge criteria & DECLARE Red List Free.	100% organic wool design felt is a rapidly renewable resource and is 100% biodegradable/compostable. Contributes points toward LEED v4, CDPH v1.2, VOC free, no chemical irritants, no formaldehyde, and is free of other harmful substances. Compliant with Living Building Challenge criteria & DECLARE Red List Free.
<b>Variation</b>	PET felt panels are created through a manufacturing process known as 'felting'. This process results in a heathered appearance. Multiple color tones may appear in the same panel. Slight color variations should be expected.	Due to its 100% natural origin, the raw fibers of wool felt contain inclusions and color variations throughout the material. Color matching is not guaranteed between dye lots and inconsistencies may be more prominent in volumes that exceed the normal commercial standard.



\*Approximate. NRC rating may vary due to product dimensions and spacing.

## Dimensions

### Standard Unit Dimensions

Typical ranges for height and width.

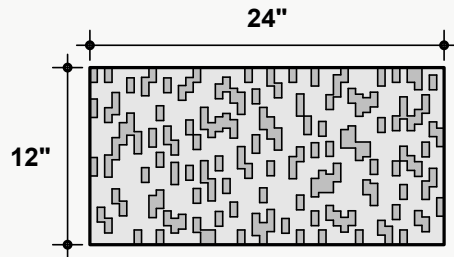

### Standard Unit Thicknesses

Thickness is dependent on material layer selection.

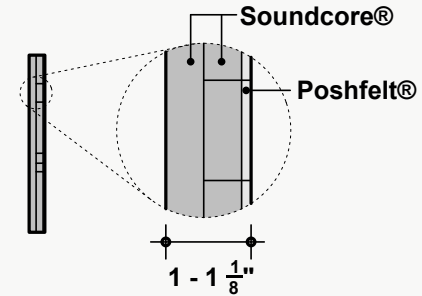

### Custom Opportunity

Product dimensions can be manipulated in order to fit your design aesthetic and site conditions.

## Product Details

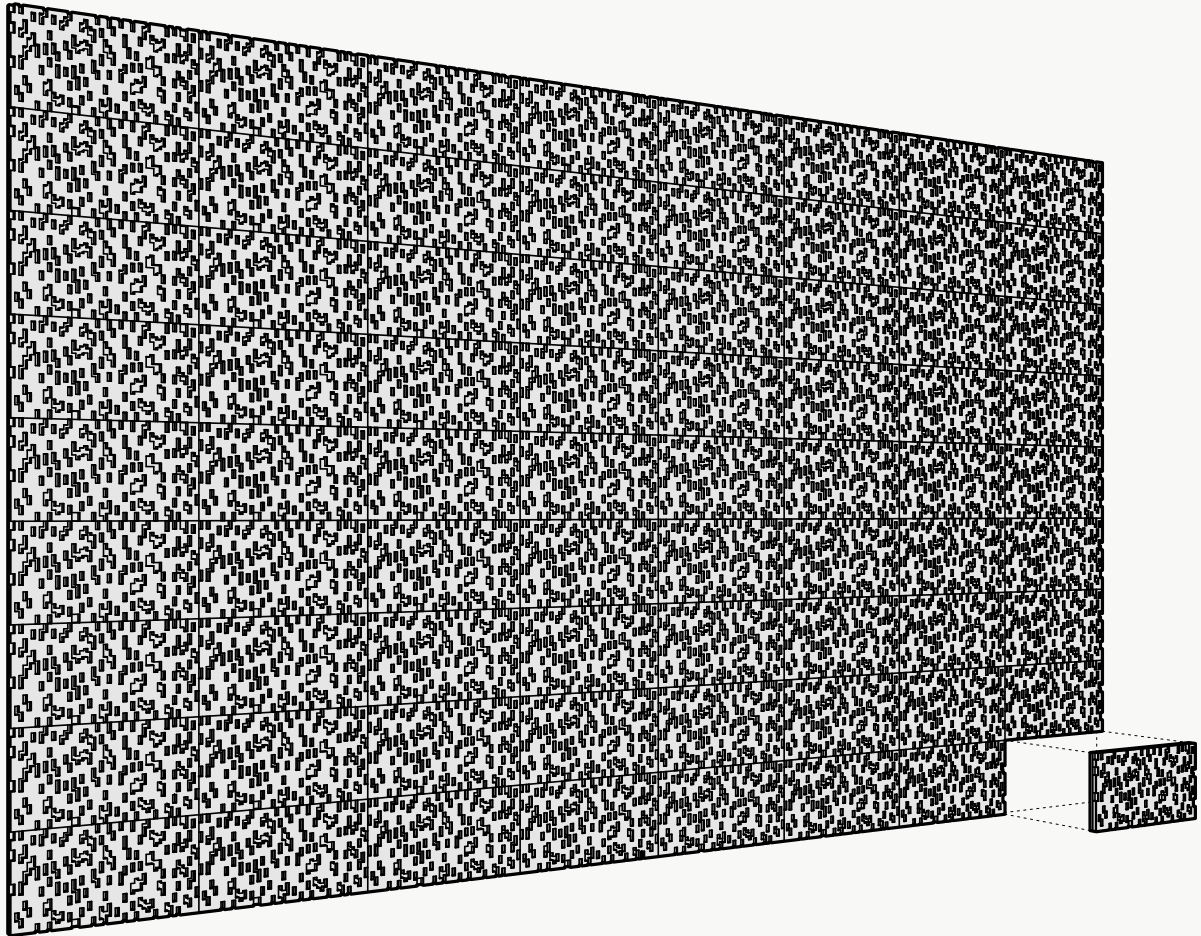



## Installation Options\*

All products and installation methods can be **customized** to meet the unique requirements of your space.

### Adhesive Direct Advantages

Attachment solution using an adhesive to apply directly to an existing surface or substrate.

- + Fastest installation time
- + No gap between target surface and product
- + Lowest profile installation option
- + Easiest to install
- + Most versatile installation option

Available methods: Construction Adhesive, Peel & Stick, Custom

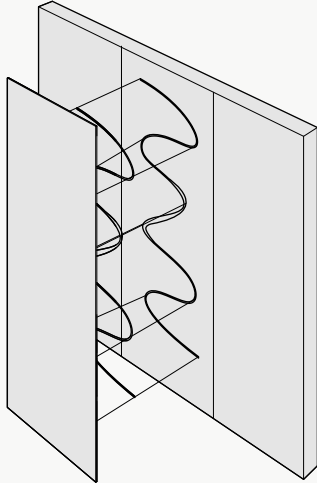

### Mechanical Direct Advantages

Attachment solution using physical hardware to attach to an existing surface or substrate.

- + No clamping or dry time necessary
- + Easy to remove and does not damage the substrate when removed
- + Most appropriate installation solution for heavier products
- + Provides an opportunity for an air gap, which can increase the acoustic value of a product

Available methods: Z-Clips, Panel Clips, Standoffs, Screw & Washer, Magnet, Custom

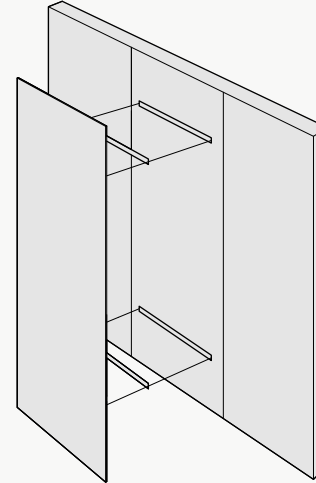

\*Not all listed attachment methods may be applicable to this product.

## Material Layers

### Soundcore®

Our recycled PET felt creates an acoustic barrier, defending against wandering white noise and irritating echoes.

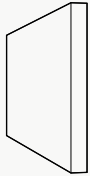

Single Layer  
½" Thickness

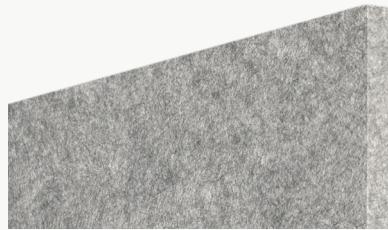

### Soundcore® Wood Textures

Soundcore® wood textures provide the natural aesthetic of wood while maintaining all the acoustic benefits of PET felt. Custom texture opportunities are also available upon request.

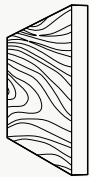

Single Layer  
½" Thickness



### PoshFelt® Exposed Edge

100% organic, natural wool design felt brings out the best experience in your space with color, comfort, and simple sustainability. Exposed edge products leave the Soundcore® layer uncovered, allowing for unique color combinations.

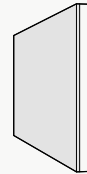

Multi-Layer  
Adds ⅛"-¼" to Material Thickness



PoshFelt® | 3mm Thickness



**PSH005**  
Black Beauty

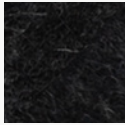

**PSH161**  
Black Swan

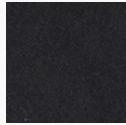

**PSH266**  
Koala

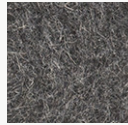

**PSH001**  
Gray Matter

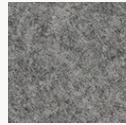

**PSH176**  
Warmstone

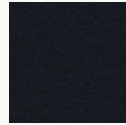

**PSH627**  
Blackberry

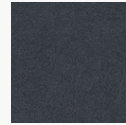

**PSH265**  
Slag

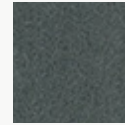

**PSH513**  
Gravel

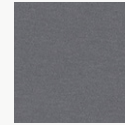

**PSH512**  
Ash Plum

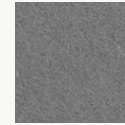

**PSH004**  
Porpoise

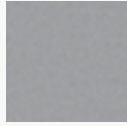

**PSH625**  
Silver Chain

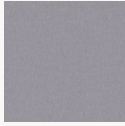

**PSH609**  
Cityscape

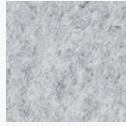

**PSH300**  
Crevasse

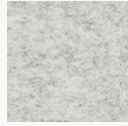

**PSH299**  
Mountain Breeze



**PSH515**  
Blizzard

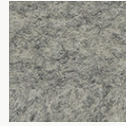

**PSH175**  
Dovetail



**PSH624**  
Dapple Gray

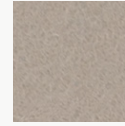

**PSH127**  
Mocha

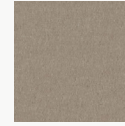

**PSH635**  
Eggshell



**PSH178**  
Fawn



**PSH520**  
Silt

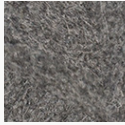

**PSH002**  
Heather



**PSH003**  
Otter

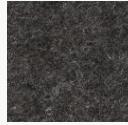

**PSH179**  
Arctic Seal



**PSH180**  
Iron Ore

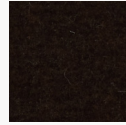

**PSH545**  
Henna

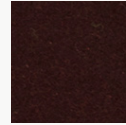

**PSH249**  
French Press



**PSH248**  
Mink

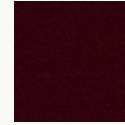

**PSH531**  
Garnet



**PSH146**  
Auburn

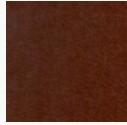

**PSH521**  
Cocoa



**PSH269**  
Canyon



**PSH253**  
Toffee



**PSH602**  
Cafe

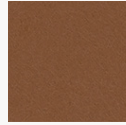

**PSH268**  
Gingerbread



**PSH255**  
Tropical Walnut



**PSH504**  
Earth



**PSH505**  
Garrigue



**PSH503**  
Savanna

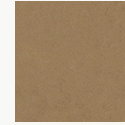

**PSH509**  
Cairo



**PSH621**  
Pan

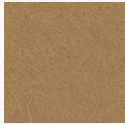

**PSH281**  
Great Plains



**PSH291**  
Gobi



**PSH630**  
Sand Dune



**PSH006**  
Shiitake

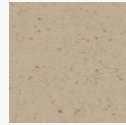

**PSH519**  
Cupcake

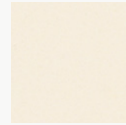

**PSH118**  
Ivory Lace

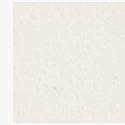

**PSH174**  
Cotton

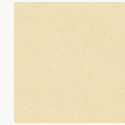

**PSH293**  
Pound Cake

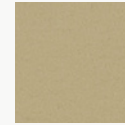

**PSH637**  
Chiffon

PoshFelt® | 3mm Thickness



**PSH304**  
Sugar Cookie



**PSH301**  
Tumbleweed



**PSH541**  
Banana Bread



**PSH622**  
Corn



**PSH215**  
Raincoat



**PSH305**  
Dandelion

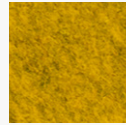

**PSH216**  
Lion's Den



**PSH015**  
Honey



**PSH217**  
Citrine



**PSH507**  
Hive



**PSH634**  
Amber



**PSH261**  
Pale Ale



**PSH638**  
Sunflower



**PSH549**  
Medallion



**PSH295**  
Sunrise Peach

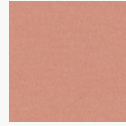

**PSH610**  
Coral

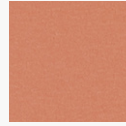

**PSH632**  
Peach



**PSH251**  
Summer Dream



**PSH218**  
Citrus



**PSH532**  
Harvest



**PSH014**  
Knockout Orange



**PSH307**  
Orange Nectar



**PSH633**  
Clementine



**PSH245**  
Fire Agate



**PSH525**  
Olympus

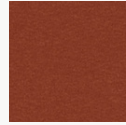

**PSH640**  
Rusted

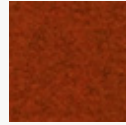

**PSH528**  
Ferrous



**PSH296**  
Paprika



**PSH220**  
Red Earth



**PSH530**  
Hot Iron



**PSH537**  
Cardinal



**PSH535**  
Guppy

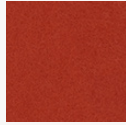

**PSH139**  
Cayenne



**PSH008**  
Bonfire



**PSH308**  
Scarlet

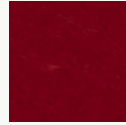

**PSH009**  
Poinsettia



**PSH540**  
Devil's Food



**PSH527**  
Red Velvet



**PSH644**  
Maroon



**PSH539**  
Mahogany

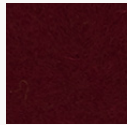

**PSH210**  
Sangria



**PSH211**  
Cherry Chutney

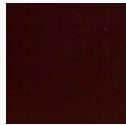

**PSH212**  
Vino

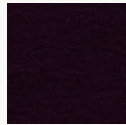

**PSH514**  
Red Wine



**PSH617**  
Evening Gown



**PSH649**  
Pomegranate

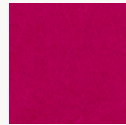

**PSH273**  
Ultraviolet



**PSH137**  
Passion Flower



**PSH272**  
Hotwire



**PSH302**  
Heather Pink



PoshFelt® | 3mm Thickness

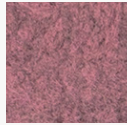

PSH292  
Sakura Mist



PSH202  
Crush

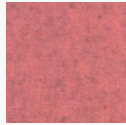

PSH560  
Schiava



PS647  
Eden Rose



PSH643  
Rhododendron

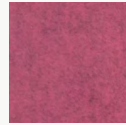

PSH559  
Monroe



PSH544  
Dragonfruit



PSH309  
Allium



PSH205  
Mulberry



PSH546  
Tyrian Plum



PSH142  
Plum Purple



PSH523  
Violet Sky

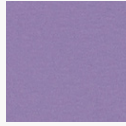

PSH612  
Lilac



PSH286  
Viper

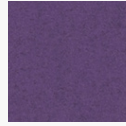

PSH646  
Lupine



PSH274  
Amethyst

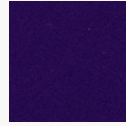

PSH275  
Skyfall

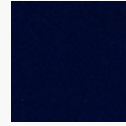

PSH241  
Tranquilo

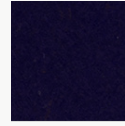

PSH550  
Mariana

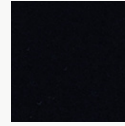

PSH277  
Shade

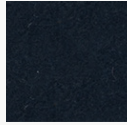

PSH310  
Deep Royal

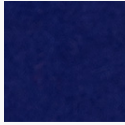

PSH160  
Admiral Blue



PSH561  
Neptune



PSH239  
Speckled Navy



PSH548  
Ultramarine



PSH645  
Space

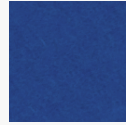

PSH508  
Oahu



PSH510  
Ozone

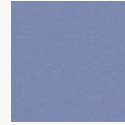

PSH615  
Imagine



PSH614  
Blueberry



PSH636  
Navy Blue



PSH278  
Squid Ink



PSH260  
Twilight

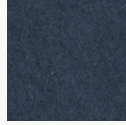

PSH601  
Royalty



PSH616  
Fountain

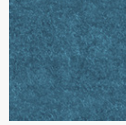

PSH604  
Atlantic



PSH237  
Hotspring



PSH238  
Cobalt

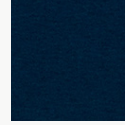

PSH516  
Actun



PSH502  
Pacific



PSH511  
Lagoon



PSH152  
Blue Nile



PSH149  
Jamaica Bay



PSH623  
Steel Gray



PSH648  
Aegean



PSH236  
Aquamarine



PSH016  
Freshwater

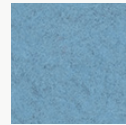

PSH306  
Swell

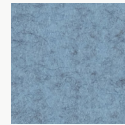

PSH608  
Diamond Dust

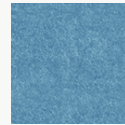

PSH605  
Meander

PoshFelt® | 3mm Thickness

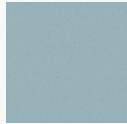

PSH639  
Glacier



PSH606  
Midday



PSH650  
Waterfall



PSH287  
Sea Breeze



PSH628  
Cozumel



PSH631  
Adriatic



PSH552  
Cancun

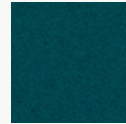

PSH564  
Jazz



PSH517  
Sky Stone



PSH232  
Seaglass



PSH641  
Basil



PSH629  
Robin's Egg



PSH642  
Blue Spruce



PSH618  
Iguana

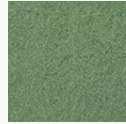

PSH213  
Meadow

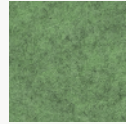

PSH303  
Feather Moss

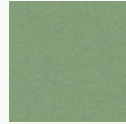

PSH619  
Springtime

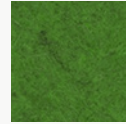

PSH223  
Matrix



PSH164  
Fresh Lime



PSH225  
Everglade



PSH226  
Grove



PSH298  
Peacock



PSH234  
Ocean Trench



PSH311  
Emerald

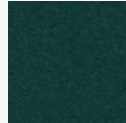

PSH626  
Evergreen

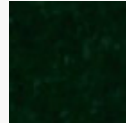

PSH553  
Conifer

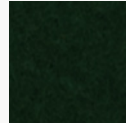

PSH228  
Forest Haze

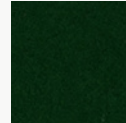

PSH227  
Succulent



PSH563  
Rosemary

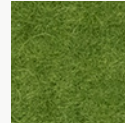

PSH555  
Hemlocks



PSH012  
Shamrock



PSH554  
Cyber Green

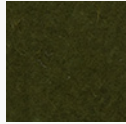

PSH501  
Mire



PSH506  
Bracken



PSH312  
Safari



PSH611  
Haybale

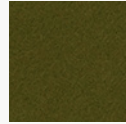

PSH230  
Camouflage

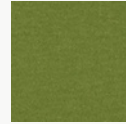

PSH556  
Avocado

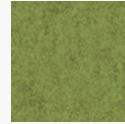

PSH562  
Aurora

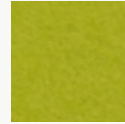

PSH013  
Parakeet

Soundcore® | 1/2" Thickness



**SND019**  
Linen



**SND037**  
Paper



**SND135**  
Oat



**SND105**  
Sand Dollar



**SND109**  
Macadamia



**SND111**  
Lanai



**SND130**  
Buckskin



**SND131**  
Abalone



**SND125**  
Chinchilla



**SND118**  
Anchor



**SND126**  
Wolfhound



**SND110**  
Starry Night



**SND102**  
Morning Fog

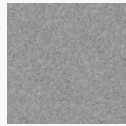

**SND114**  
Lunar Dust



**SND034**  
Granite Peak

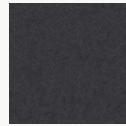

**SND132**  
Cast Iron

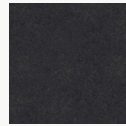

**SND103**  
Storm Cloud



**SND038**  
Inkwell



**SND122**  
Briquette



**SND127**  
Burnt Toast

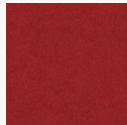

**SND108**  
Ablaze



**SND104**  
Pumpkin



**SND106**  
Goldfinch

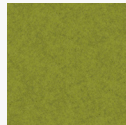

**SND113**  
Gruner



**SND107**  
Grasshopper

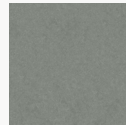

**SND129**  
Dried Thyme

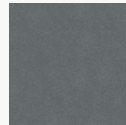

**SND115**  
Mako



**SND112**  
Tulum

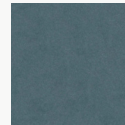

**SND121**  
Apatite

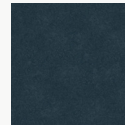

**SND123**  
Chrysocolla



**SND117**  
Serene



**SND124**  
Ice Floe

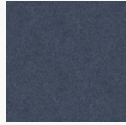

**SND128**  
Arctic Ocean



**SND133**  
Galactic



**SND116**  
Blue Marlin

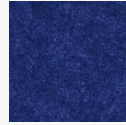

**SND101**  
Commodore



**SND042**  
Denim

Soundcore® Wood Textures | 1/2" Thickness



**SND716**  
Dark Teak



**SND792**  
Dark Oak



**SND715**  
Dark Cherry



**SND793**  
Vintage Maple

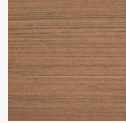

**SND794**  
Warm Teak

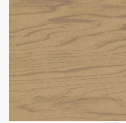

**SND714**  
English Walnut

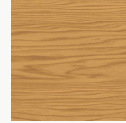

**SND713**  
Honey Walnut

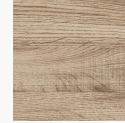

**SND717**  
Warm Oak

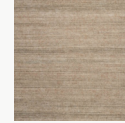

**SND790**  
Natural Teak

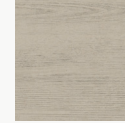

**SND712**  
Natural Spruce



**SND711**  
Bleached Cherry



**SND795**  
Light Teak



**SND709**  
White Maple

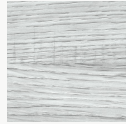

**SND791**  
Gray Oak



**SND710**  
Gray Teak